



CODE: 03140

CONTENTS

1. Welcome
2. Overview
3. Safety warnings
4. Installation
5. Mounting options
6. Terminal block wiring
7. Maintaining your Mercury III Jumbo
8. Replacing the battery
9. Battery life
10. Power and battery charge
11. Wireless daughterboard
12. Self test / standard wiring / central battery system
13. DALI wiring / central battery system
14. Using the inverter with a switch
15. Using the inverter with a sensor
16. Accessories list
17. Non maintained / maintained jumper
18. Discharge rating selection
19. Self test indicator LEDs
20. Self test / commissioning interval programming
21. Product specifications
22. Spacing table
23. Australian emergency classification
24. Construction sites
25. Testing precautions
26. Problem solving procedure
27. Warranty information
28. Compliance standards
29. Technical support and troubleshooting

I. WELCOME

Thank you for choosing this quality Ektor product. This manual is intended to help you install this product in a way that ensures the safety of yourself and others. Whilst this Ektor product is designed to be installed easily, we highly recommend you take the time to read this manual thoroughly before commencing installation. When installed correctly and serviced regularly, this product will provide hassle free operation for many years.

2. OVERVIEW

Ektor Generation III platform introduces you to a new era of emergency lighting control. With years in the making, the third generation platform builds on the Ektor product ranges' increasing quality, reliability and performance. In choosing this Ektor product you can be comfortable that you have the best.

This product out of the box can be wired in any of these configurations:

- Self testing unit
- Standalone unit
- Standalone unit controlled with a switch or sensor
- DALI controlled remote testing unit

And can be used with a central battery system (monitored and non-monitored).

An optional wireless module can be added to allow you to connect to standard Wi-Fi networks for remote testing and reporting.

Our Ektor Generation III platform also brings class leading technology which increases performance and reliability including:

- Smart battery charging technology which reduces power consumption up to 90% while increasing the service life of the battery
- Smart battery conditioning to ensure the best performance from the battery
- 450V Electrolytic capacitors which increase the products reliability
- Highly efficient design to reduce fatigue on the product

For buildings requiring longer durations such as 3, 4 and 8 hours the installer can change the jumpers found on the unit for automatic scaling of the output. Moreover should you require non-maintained or maintained output, the installer can select this on installation.

3. SAFETY WARNING

1. THIS PRODUCT MUST ONLY BE INSTALLED BY A LICENSED ELECTRICIAN.
2. BEFORE COMMENCING INSTALLATION TURN OFF AND ISOLATE THE ELECTRICAL SUPPLY.
3. RISK OF ACCIDENTAL CONTACT WITH LIVE PARTS. DO NOT ENERGISE WITH PRODUCT OPEN OR DISASSEMBLED.
4. SUPPLY VOLTAGES WITHIN PRODUCT. ISOLATE SUPPLY VOLTAGES BEFORE OPENING OR SERVICING.
5. THIS LUMINAIRE IS SUITABLE FOR USE IN HIGH-RISK TASK AREA LIGHTING.
6. MAINS SUPPLY AND BATTERY CIRCUIT SEPARATED BY REINFORCED INSULATION.
7. THE ONLY USER SERVICEABLE / REPLACEABLE PART IS THE BATTERY PACK.
8. DO NOT ATTEMPT TO SERVICE OTHER PARTS OF THE FITTING AS THIS WILL VOID THE WARRANTY.
9. AS THE INSTALLER, IT IS YOUR RESPONSIBILITY TO ENSURE YOU COMPLY TO ALL RELEVANT BUILDING AND SAFETY CODES FOR EXAMPLE THE BCA, AS3000. REFER TO APPLICATION STANDARDS FOR THE RELEVANT RULES.

4. INSTALLATION

Ektor Mercury III Jumbo can be installed via surface, rod, or chain mounting. To install the Mercury III Jumbo please follow the steps listed below:

1. Remove the product from the box and inspect it for any damage. If you believe the product to be damaged or otherwise unsound, **DO NOT** install the product. Please pack it back into its box and return it to the place of purchase for replacement. If the product is satisfactory, proceed with the installation.

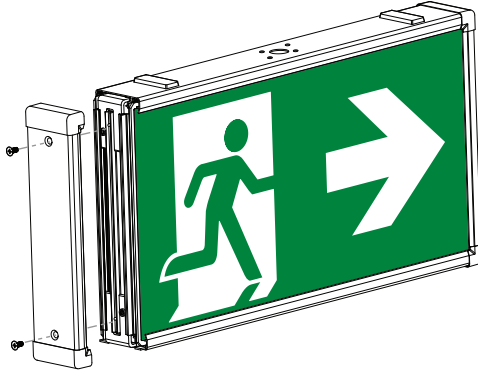

Figure 1: Mercury III Jumbo disassembly

2. Unscrew either side panel with a Phillips screwdriver. Remove the panel by pulling gently away from the product body as shown in **figure 1**.
3. The Mercury III Jumbo decals and diffuser can be removed by sliding them across as shown in **figure 2**.

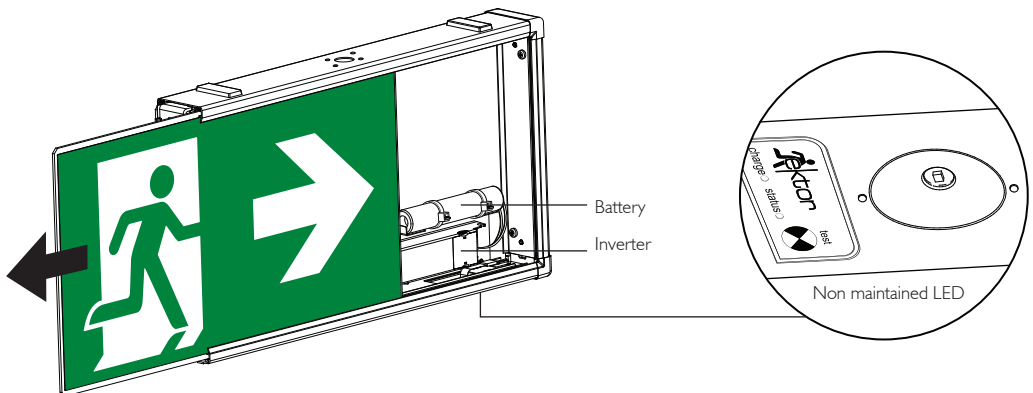

Figure 2: Mercury III decal removal

Instructions continue on **page 4**

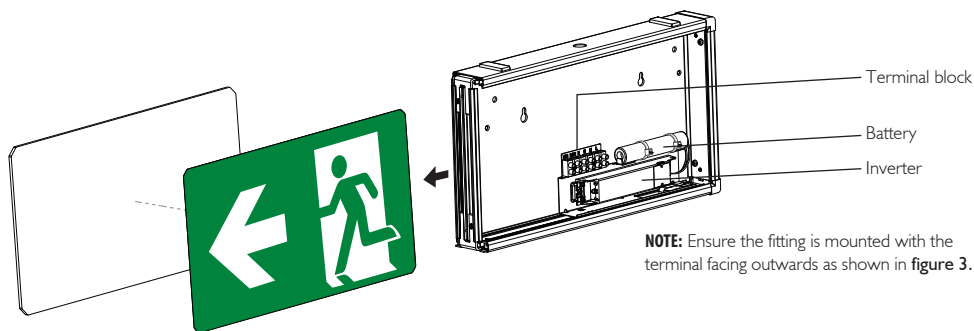

Figure 3: Mercury III Jumbo cover removal

4. Removing the decal and diffuser allows access to the Mercury III Jumbo battery and inverter for wiring, servicing and maintenance purposes.
5. The disassembly of the Mercury III Jumbo is also necessary for the installation using a Rod Mount Kit. Installation instructions for the Rod Mount can be found in **section 5 (page 5)** of this manual.
6. The Mercury III Jumbo can be mounted as shown in **section 5**. The Mercury III Jumbo can then be wired and reassembled by reversing the disassembly process.

5. MOUNTING OPTIONS

SURFACE MOUNT

1. Remove decal and diffuser as shown in the disassembly instructions in **section 4 (page 3)** of this instruction manual.
2. The Mercury III Jumbo has an aluminium backing plate for surface mounting installed by default. Install the four included feet by pressing into the holes provided and inserting retaining pin. When used with other mounting options, the backing plate can be replaced with a second diffuser and decal for double sided use.
3. Position and mount the Mercury III Jumbo on a flat surface and fasten with the appropriate fixing as shown in **figure 4**.

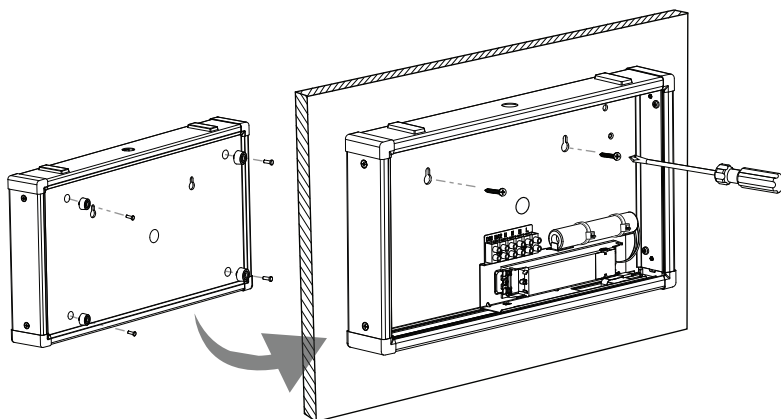

Figure 4: Mercury III Jumbo installation

ROD MOUNT

Refer to **01990 EV-RODMOUNT Installation guide** included in rod mount kit.

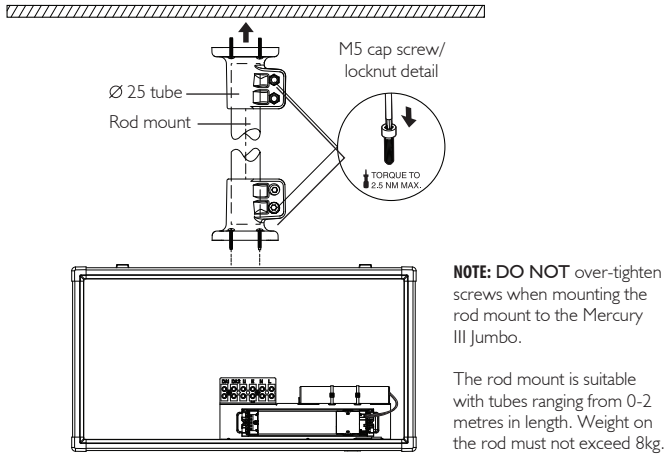

Figure 5: Rod mount installation

The product and rod **MUST BE** dry and clean before assembly to avoid joint contamination.

1. Disassemble the Mercury III Jumbo as shown in the disassembly instructions in **section 4 (page 3)** of this manual. This will allow for the rod mount to be assembled with the Mercury III Jumbo top cover.
2. Remove aluminium backing plate and replace with second diffuser and decal as appropriate for installation.
3. Ensure rod is mounted **ONLY** on a flat surface and fasten with the appropriate fixing i.e. masonry anchor for concrete.
4. A $\varnothing 25$ tube is to be used, pushed firmly on both ends and fastened with M5 cap screws and locknuts.

JACK CHAIN MOUNT

1. When using a jack chain for mounting, ensure the suitable thickness of 2.5mm chain is used for this product.
2. Remove aluminium backing plate and replace with second diffuser and decal as appropriate for installation.
3. The surface cover must be threaded with the chain first before assembly of the Mercury III Jumbo. Instructions continue on **page 6**.

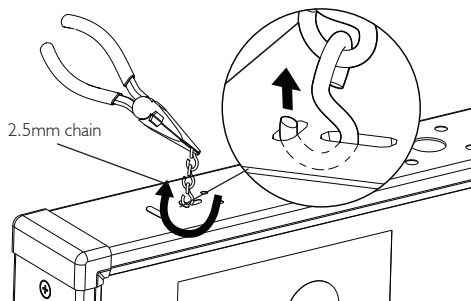
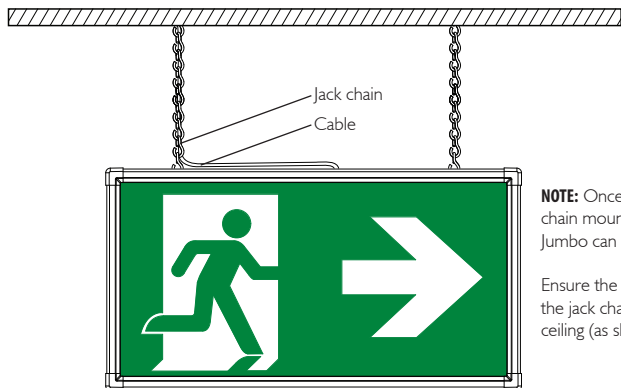

Figure 6: Mercury III Jumbo and jack chain assembly

NOTE: Removing backing plate requires detachment of earthlink

- Using pliers clamp the jack chain and thread through the Mercury III Jumbo top cover as shown in figure 7.



NOTE: Once the product has been chain mounted the Mercury III Jumbo can be reassembled.

Ensure the cable is secured onto the jack chain and run up into ceiling (as shown in figure 7).

Figure 7: Jack chain installation

6. TERMINAL BLOCK WIRING

Wiring schematic for the terminal block used with the Mercury III Jumbo is illustrated below.

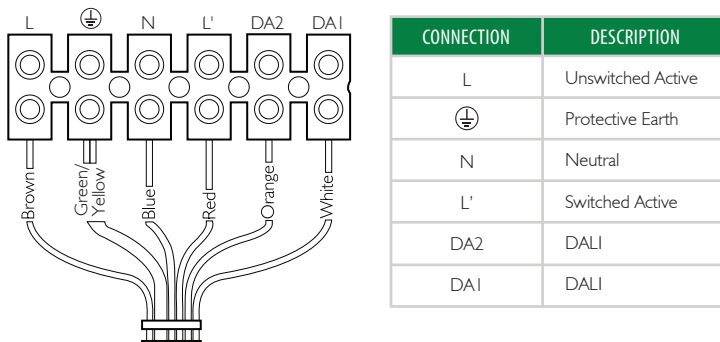

Figure 8: Wiring schematic

7. MAINTAINING YOUR MERCURY III JUMBO

⚠ WARNING

The Ektor Mercury III Jumbo is connected to an unswitched active during normal operating conditions. When disconnected from the mains supply, the Mercury III Jumbo is powered by a LiFePO4 battery operated inverter. Due to this, care should be taken when replacing the battery.

8. REPLACING THE BATTERY

1. Use only the LiFePO₄ battery recommended on the label found on the inverter/battery charger pack. No other battery will work in this fitting, other than the type listed.
2. Access the battery by removing the product cover as shown in **section 4 (page 3)** of this manual.
3. Disconnect the battery from the product and if necessary, cut cable ties to release the battery from its mounting position.
4. Replace the battery as was previously installed. The battery can be connected in one direction only, do not force. Secure with cable ties.
5. Replace the diffuser decal and side cover and ensure the green charge light is illuminated. Allow a few minutes for the battery to charge.
6. Allow a minimum 24 hours charging time before carrying out any discharge tests as per the requirements in AS/NZS 2293, BCA or other relevant standards.

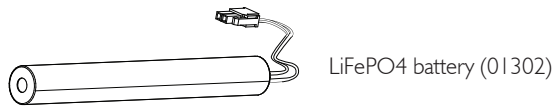

Figure 9: Example of included battery

9. BATTERY LIFE

To maintain the economical life of this product it is required that the battery be discharged and recharged at least once every 6 months. The battery life can be reduced if the battery is not discharged as per the requirements of AS/NZS 2293 or an equivalent standard. Increasing the number of duration tests above that as defined in AS/NZS 2293 or an equivalent standard can have a positive effect on the battery performance as long as exceed 12 discharge cycles per year is not exceeded

10. POWER AND BATTERY CHARGE

The Ektor Generation III platform uses smart battery charging technology which reduces power consumption and increases battery life.

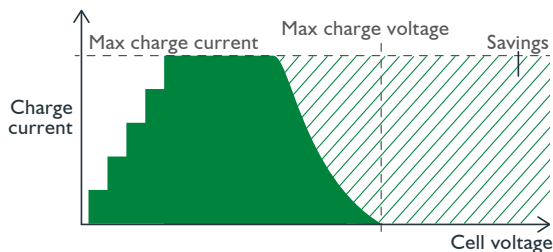

Figure 10: Smart charge rate

During the first stage of operation the battery charger charges the battery until full. Afterwards, the unit goes into a stage which charges the battery periodically. This reduces the battery temperature and reduces the loss of electrolytes which ultimately increases the service life of the battery. As a result of stopping the charging process, the power consumption is reduced and only consumes 1/11 th of the typical power.

The smart battery charger also offsets the charger time by a random interval to un-synchronise all the emergency lighting in the building. This reduces the average loading on a building's infrastructure and reduces any impacts of surges created by turning on large numbers of products simultaneously.

11. WIRELESS DAUGHTERBOARD

The Mercury III Jumbo inverter also supports an optional wireless daughterboard. More information and a list of other accessories can be found in the **Wireless design and installation guide**. The assembly for this part onto the inverter is shown below:

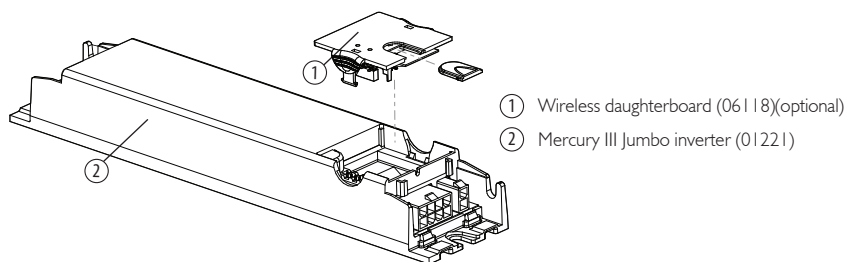

Figure 11: Daughterboard assembly diagram

12. SELF TEST/ STANDARD WIRING/ CENTRAL BATTERY SYSTEM

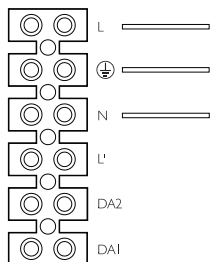

Figure 12: Inverter standard wiring diagram

The inverter can be used in an automatic self-test mode which reduces the need for a test switch timer. The self-test ability automatically disables if the unit is wired to DALI or the wireless daughterboard is attached. Additionally the third generation platform can be wired to a central battery system. With this wiring the system cannot report the light status (see **Self test support** document for more information).

13. DALI WIRING / CENTRAL BATTERY SYSTEM

The Mercury III Jumbo inverter supports DALI out of the box, a hardwiring diagram is shown below, optionally an installer can order a soft wiring cable set. The inverter also supports central battery systems and can be monitored through DALI. When used as a central battery system the devices can be tested with DALI.

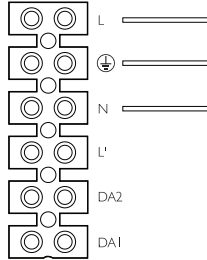

Figure 13: Inverter DALI wiring diagram

14. USING THE INVERTER WITH A SWITCH

A mains rated switch can be wired with this product to turn ON/OFF the non-emergency light in normal use. This does not affect operation in emergency mode.

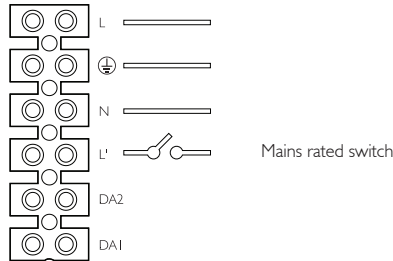

Figure 14: Inverter switch wiring diagram

15. USING THE INVERTER WITH A SENSOR

A mains rated sensor can be wired with this product to turn ON/OFF the light in normal use. This does not affect operation in emergency mode.

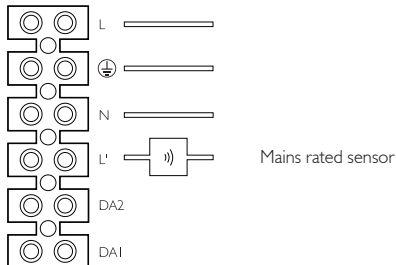

Figure 15: Inverter sensor wiring diagram



16. ACCESSORIES LIST

Below are the listings of the accessories and replacements compatible with the Mercury III Jumbo.

PART	EVOLT CODE	CODE
COMPLETE UNITS Mercury III Jumbo 40M	EV-MERCURY-III-40M	03140
PARTS/REPLACEMENTS Mercury III Jumbo 40M Inverter 1500mAH 64V 2 cell LiFePO4 Battery Mercury III Jumbo 40M Decals Wireless Daughterboard Rod Mount Kit	EV-MERCURY-III-40M-INV EV-1500MAH-6.4V-LIFEP04 EV-MERCURY-III-40M-DP EV-WIFI-DAUG EV-RODMOUNT-WHT	01221 01302 01999 06118 01990

17. NON MAINTAINED/ MAINTAINED JUMPER

A user can select the mode of operation for the Mercury III Jumbo inverter. If the inverter is using a switch input this is disregarded and not used.

INDICATOR	STATUS	DESCRIPTION
NON MAINTAINED		LED is only ON in emergency
MAINTAINED MODE		LED is ON in normal and emergency operation

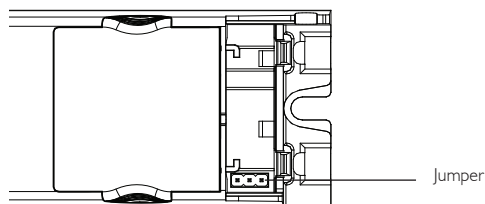

Figure 16: Maintained/non-maintained jumper

18. DISCHARGE RATING SELECTION

The Mercury III Jumbo supports a number of discharge ratings which can be selected by the user. The output from the LED scale based on the discharge rating (see section 23 for output information).

HOURS	A	B	C
1 Hour	OFF	OFF	OFF
2 Hours (default)	ON	ON	ON
3 Hours	ON	ON	OFF
4 Hours	ON	OFF	ON
N/A	ON	OFF	OFF
Central battery operation	OFF	ON	OFF
N/A	OFF	ON	ON
N/A	OFF	OFF	ON

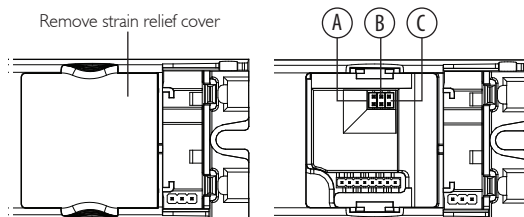





Figure 17: Discharge rating selection

19. SELF TEST INDICATOR LEDS

The table below shows the operation of the Mercury III Jumbo status indicators:

INDICATOR	DESCRIPTION
 YELLOW 2sec ON / 2sec OFF	Device is performing a duration test
 YELLOW 4sec ON / 1sec OFF	Last duration test passed. The duration was met when last run. Test ran less than five days ago
 YELLOW 0.5sec ON / 0.5sec OFF	Last duration test failed. Failed to meet duration. The device is not currently running a new test. Mains is on
 GREEN 1x Flash	A duration test is pending. The device is not in any self test and is set to normal mode

20. SELF TEST/ COMMISSIONING INTERVAL PROGRAMMING

The self test mode must first be enabled to perform tests by switching the breaker, or test button in the correct sequence. The test interval is fixed and set to 26 weeks / 182 days. The LEDs indicate the status of the device and which functions are being performed. For more information refer to the **Configurations: Status LEDs and Device Modes** document.

When self test mode is enabled the status LED will flash either 4x (switched active detected) or 3x (switched active not detected) for 2 minutes.

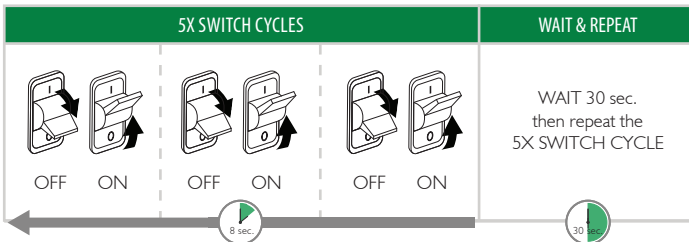

The self test can also be enabled using the test button sequence below:

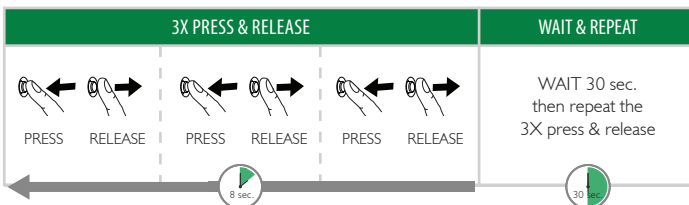

NOTE: If the wait in-between breaker or test button push sequences is longer than **50 seconds** then it will time-out and the procedure will need to begin again.

21. PRODUCT SPECIFICATIONS

MERCURY III JUMBO 40M

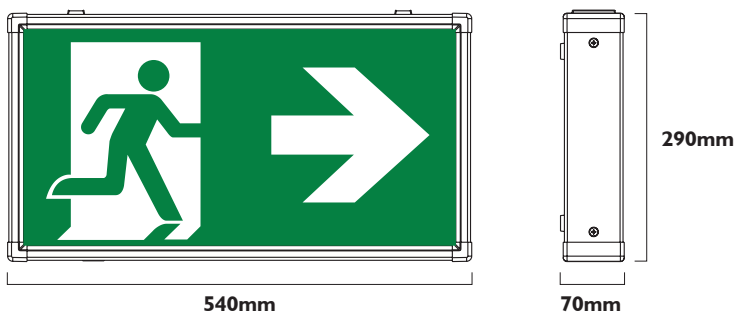

Voltage (V)	220~240V	Viewing Distance	40M
Frequency (Hz)	50	Mounting Type	Surface, rod, jack chain
Ambient Temp.	0 - 40°C	Wiring	Hardwired (1-16mm □)
Battery Type	LiFePO4	Battery Voltage	6.4V
Class	I	Charging Time	16 hours
Duration	Depending on jumper	Charger Operation	Multi State
IP Rating	IP20	Charger Type	Smart charge
Maintained Power Consumption	Max 4.5W	Average	2.35W
Non Maintained Power Consumption	3W		2.5W

22. SPACING TABLE

Below is the spacing table extract from A52293 which details spacing between emergency fittings at different mounting heights.

LUMINAIRE CLASSIFICATION	MOUNTING HEIGHT (M)												
	2.1	2.4	2.7	3	3.3	3.6	4	4.5	5	6	7	8	9
D4	7.2	7.3	7.3	7.3	7.3	7.2	6.9	6.5	5.8	3.1			
D6.3	8.6	8.8	9.0	9.1	9.2	9.2	9.2	9.0	8.7	7.7	5.7		
D10	10.2	10.6	10.9	11.1	11.3	11.4	11.5	11.6	11.6	11.2	10.3	8.9	6.7

23. AUSTRALIAN EMERGENCY CLASSIFICATION

Classification of the Mercury III Jumbo output when duration is selected.

HOURS	MERCURY III JUMBO 40M
1	D10
2	D10
3	D6.3
4	D4

24. CONSTRUCTION SITES

IMPORTANT NOTE: Continuously switching the power supply to the fitting on and off during or after the installation process due to other processes being conducted on the building site could cause the fitting to discharge and charge its battery many times during a short period which can impact negatively on the battery life. It is not recommended that you connect the Ektor emergency products to the power supply if such conditions are prevalent. If you choose to expose the Ektor emergency products to such harsh operating conditions, Evolt may not honour any warranty on the life of the batteries or the dish. This Ektor emergency product is designed to undergo regular discharge tests but it is recommended that the intervals between consecutive tests are not less than two weeks. Frequent testing of the exit product will reduce the service life of the battery. In order to prevent damage to the battery, leave the unswitched active circuit turned off at the circuit breaker until such time as emergency lighting is required

25. TESTING PRECAUTIONS

When the Ektor emergency product is permanently connected to the mains supply you will need to allow 24 hours to charge its battery. Once the battery is fully charged you will need to conduct a manual discharge test as per the requirements of AS/NZS 2293 or other relevant standards. At the time of printing, the Australian standard requires that new fittings operate in emergency mode for at least 2 hours for their first discharge test. Further tests are to be carried out at intervals of not more than six months. It is important that you keep records of the initial test and ongoing tests in the building's emergency service logbook. If the fitting is not to be permanently connected to the mains supply at the time of installation, you must give it the mandatory 2 hour test when you connect it permanently to the mains supply.

26. PROBLEM SOLVING PROCEDURE

If you have installed and connected the Mercury III Jumbo as per the instructions contained within this manual and the product fails to work properly, please use the following table as a guide to fixing the problem before calling our office.

FAULT	POSSIBLE CAUSES
Green LED is not lit	<ul style="list-style-type: none">• AC Supply is not connected• AC Supply turned off• Battery plug not connected to battery pack
Green LED is lit but the lamp does not light when the test switch is pressed	<ul style="list-style-type: none">• Lamp is damaged• Lamp is not inserted properly• Battery pack is damaged
Lamp lights, but only temporarily, when test switch is pressed or when the main power supply is turned off	<ul style="list-style-type: none">• Battery pack not fully charged• Battery pack is damaged

27. WARRANTY INFORMATION

Ektor products are distributed in Australia and New Zealand by Evolt Pty Ltd (Evolt).

The Australian Consumer Law as well as other Australian laws guarantee certain conditions, warranties and undertakings, and give you other legal rights, in relation to the quality and fitness for purpose of Ektor products sold in Australia.

In Australia, our goods come with guarantees that cannot be excluded under the Australian Consumer Law. You are entitled to a replacement or refund for a major failure and compensation for any other reasonably foreseeable loss or damage. You are also entitled to have the goods repaired or replaced if the goods fail to be of acceptable quality and the failure does not amount to a major failure. What constitutes a major failure is set out in the Australian Consumer Law.

Nothing in this Warranty purports to modify or exclude the conditions, warranties and undertakings, and other legal rights, under the Australian Competition and Consumer Act and other Australian laws.

Ektor products are warranted in Australia for a period of 12 months from the date of delivery of the product, provided that the products are properly stored, installed, used and maintained in accordance with the instructions contained within their manual.

Products that have been altered in any way or used other than in accordance with their instructions are not covered by this Warranty.

This Warranty is not transferable and is valid only in the hands of the purchaser of the product. The warranty does not cover Ektor products other than those purchased from Evolt. Proof of purchase must be provided to Evolt with any warranty claim. Evolt recommends that the purchaser attaches their proof of purchase to their product manual.

If you wish to claim under this Warranty, you must, at your own expense, return the product or that part of the product which you believe is defective, and proof of original purchase, your name, address and telephone number and a certificate of installation or other document required by the law for the installation of electrical products in the place in which the product was installed, to Evolt Pty Ltd at PO Box 271 Kingsgrove NSW 1480 within 12 months from the date of purchase. Please note that the Warranty does not cover removal or reinstallation of the product or that part of the product which you believe is defective.



Evolt's total liability under this Warranty is limited to the cost of repair or replacement of the faulty product. Evolt may satisfy its obligations under this Warranty in full by repair or replacement of a faulty product.

This Warranty does not apply to consumable items such as lamps or batteries or other items that can be classified as consumable.

For the avoidance of any doubt, any and all warranties or conditions which are not guaranteed under the Australian Competition and Consumer Act or the Australian Competition and Consumer Regulations 2010 and which are not expressly included in this Warranty as additional warranties or conditions are excluded.

This Warranty does not cover loss or damage caused by wear and tear, misuse, incorrect installation or operation, failure to clean and maintain, incorrect voltage or non-authorized electrical connections, adverse external conditions (such as power surges and dips, acts of God, exposure to heat, corrosion, insect or vermin infestation), use of non-authorized or defective parts or globes, or to items that have been repaired other than by Evolt or a repairer approved by Evolt.

28. COMPLIANCE STANDARDS

	STANDARD	TITLE
Australian/ New Zealand Standards 	AS/NZS 2293-3:2005+A1:2010	Emergency escape lighting and exit signs for buildings. Part 3: Emergency escape luminaires and exit signs.
	AS/NZS 60598-2-22:2005	Luminaires Part 2.22: Particular requirements - Luminaires for emergency lighting (IEC 60598-2-22, Ed. 3.1(2002) MOD).
	AS 61000.3.2:2007 + A1:2009	Electromagnetic compatibility (EMC) - Limits - Limits for harmonic current emissions (equipment input current (16 A per phase) (IEC 61000-3-2, Ed.3.0 (2005) MOD).
	AS/NZS CISPR 15:2011	Limits and methods of measurement of radio disturbance characteristics of electrical lighting and similar equipment.
European Committee for Standardisation 	EN 60598-1:2008+A11:2009	Luminaires - Part 1: General requirements and tests.
	EN 60598-2-22:1998+A1:2003+A2:2008	Luminaires - Part 2-22: Particular requirements - Luminaires for emergency lighting.
	EN 55015:2006+A1:2007+A2:2009	Limits and methods of measurement of radio disturbance characteristics of electrical lighting and similar equipment.
	EN 61547:2009	Equipment for general lighting purposes - Electromagnetic compatibility (EMC) immunity requirements.
	EN 61000-3-2:2006+A1:2009+A2:2009	Electromagnetic compatibility (EMC) Limits. Limits for harmonic current emissions (equipment input current \leq 16 A per phase).
	EN 61000-3-3: 2008	Electromagnetic compatibility (EMC) - Part 3-3: Limits - Limitation of voltage changes, voltage fluctuations and flicker in public low-voltage supply systems, for equipment with rated current \leq 16 A per phase and not subject to conditional connection.

29. TECHNICAL SUPPORT AND TROUBLESHOOTING

For further assistance in using this product, consult your nearest wholesaler or Evolt Pty Ltd.

Ph: + 612 9502 1161
Fax: + 612 9502 1154
Email: sales@evolt.com.au
evolt.com.au

Reference: 609031 VI.6

evolt
the electrical evolution